

# 84 & 85 SERIES

## 7" Bag Filter Housing

The **84 & 85 Series** bag housings are designed for use with the industry standard **DuoLine G Series 7"** ring style bags widely used in today's process industries. The top opening style is equipped with a Cast Vee clamp as standard with the option of Rathmann style hinged and bolted closures for pressures up to 10 bar g. The housing will accept the full range of Amazon and industry standard bags ranging from 1 to 1000µm with nominal lengths of 16" (P1) and 32" (P2) and Amazon's own 48" triple length bag.

The **84 Series** is free standing with side inlet and outlet connections. These standard diameter filter housings offer great flexibility in terms of high flow and high dirt capacity whilst requiring only a limited footprint.

Use of the inverted dished end style free standing **84 Series** housing is ideally suited to continuous process operations where economy and low volume hold up is paramount.

The **85 Series** is infinitely flexible with adjustable legs and bottom outlet connection, making it ideal for batch applications, where free draining and frequent process changes take place. Widely used in the chemical process world, the **85 Series** housing, when equipped with the optional Rathmann style hinged and bolted closure, has proved to be the most popular model produced today.

Distinguished by its economy, high build quality and wide ranging options list, this housing can be used in almost all areas of the liquids processing industry.

### Product Features

- Positive bag seating mechanism to minimise risk of seal bypass
- Robust bag support basket assembly fabricated from perforated sheet rather than wire mesh for extra strength
- Internally and externally electropolished as standard
- Wide range of options available for connection sizes and types and materials of construction
- Rated up to 10 bar g liquid, 4.5 bar g gas





### 84 Series housings feature:

- Vee clamp or hinged and bolted style closures
- Inverted dished end
- PED and ATEX Compliant

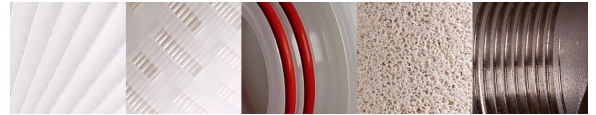
### 85 Series housings feature:

- Vee clamp or hinged and bolted style closures
- Conventional dished end to aid clean down
- Each housing hydrostatically pressure tested
- PED and ATEX Compliant



Accessories		Part Number
Pressure Gauge and Vent Valve Kit		60S000016
Pressure Gauge and Auto Vent Valve Kit		60S000082
Displacement Pod		80S011S01 80S012S01
Adjustable leg assembly		85S010003

## Features and Benefits

- Integral vent to aid efficient filter changeout
- Each housing is etched with a unique serial number for full traceability
- Full housing customisation service available
- Internally and externally electropolished as standard

## Product Range

Amazon Filters design and manufacture an extensive range of liquid filtration systems, providing one of the widest selections of filtration vessels, depth filters and pleated cartridges available today, ensuring excellent process and filter compatibility. As one of Europe's leading manufacturers of filtration systems, Amazon Filters is able to offer a solution to meet all filtration requirements. Amazons' filters are manufactured in clean room conditions and all products come with detailed Product Validation Guides and Technical Support documentation.



# 84 & 85 Series Technical Data

## Maximum Operating Conditions

Pressure Range:	Vee clamp	Screw clamp
Liquid:	10 bar g	FV/10 bar g
Gas Group 2:	4.5 bar g	FV/4.5 bar g
	*4 bar g	*FV/4 bar g

\*84013 (Triple Bag Length)

Temperature Range:	-10°C / 150°C	-10°C / 150°C
--------------------	---------------	---------------

## Materials of Construction

Body:	316L St. Steel
Closure:	Cast Clamp - 304 St. Steel
	Screw clamps - Zinc plated carbon steel (Optional stainless steel)

## Finish

Vessel:	Electropolished
Basket:	Pickled

## Connections

Inlet / Outlet:	2" BSPM
Vent:	¼" BSPM with Cap
Drain:	½" BSPM (84 Series Only)

Model	Dimensions					Volume (Litres)	Dry Weight (kg)
	A	B	C	D	E		
84011UAN20A1EE	734	553	100	300	300	19.7	15.2
84012UAN20A1EE	1094	913	100	300	660	31.0	21.1
84013UAN30A1EE	1564	1353	135	320	1050	46.0	29.0

## PED Status:

Fluid Groups:	Compliant with 2014/68/EU
	<b>84 Series</b> <b>85 Series</b>
	Liquids Group 2                      Liquids Group 1 and 2
	Gas Group 2                              Gas Group 2

Marking:

CE

Exceptions:

Group 1 liquids - Explosive

## ATEX:

Compliant with 2014/34/EU, level CE Ex II 2 GD c X

Technical drawings for each individual housing showing dimensions, volume, weights, maximum temperatures and design pressures available on request.

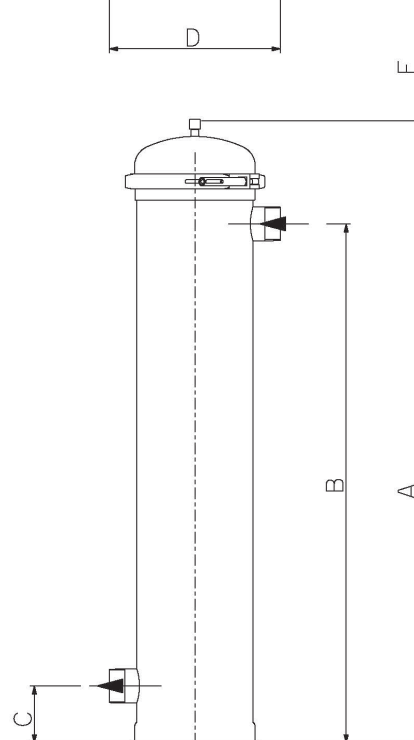
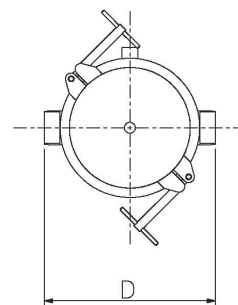

# AMAZON FILTERS LTD.

Albany Park Estate, Camberley, Surrey, GU16 7PG, ENGLAND

Tel: +44 (0) 1276 670 600 Email: sales@amazonfilters.co.uk Web: www.amazonfilters.com